

# TGL

TARIMSAL İLAÇLAMA MAKİNALARI YEDEK PARÇALARI  
AGRICULTURAL SPRAYING SPARE PARTS



# ARARAT

## شرکت تجارت گستر آرات کاتالوگ قطعات سمپاش

Tabriz office: in front of Motogen Company, Automotive Technology Town

041 3448 4550 – 041 3448 4551

WWW.ARARAT-CO.COM Araratcompany

دفتر تبریز: روبروی شرکت موتوژن، شهرک فناوری خودرو

041 3448 4550 041 3448 4551

0914 324 8030 0914 461 3868

# انواع ست درب مخزن

01000

400 LT PASOLU KAPAK / THREADED TANK LID

100 LT-200 LT-400 LT-600 LT HACİMLİ DEPOLAR İÇİN ÜSTEN PERÇİNLİ KAPAK ÇEMBERİ ŞAMANDIRALI HAVALANDIRMA

100 LT-200 LT-400 LT-600 LT TANKS / RING FOR FLAT SURFACES FLOATING VENT VALVE

01010K



01005



01012

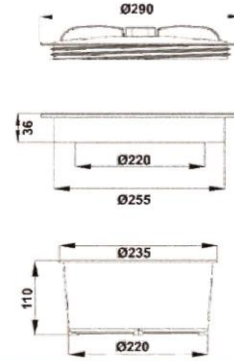

YEDEK PARÇA / SPARE PARTS



Üstten Perçinli  
Flat Surfaces



01005

ÇEMBER  
RING



01012

ELEK  
BASKET FILTER



01013K

HAVALANDIRMA VALFİ  
FLOATING VENT VALVE

01100

TONLUK PASOLU KAPAK / THREADED TANK LID

800 LT - 1000 LT - 1200 LT - 1500 LT - 1600 LT - 2000 LT HACİMLİ DEPOLAR İÇİN ÜSTEN PERÇİNLİ KAPAK ÇEMBERİ ŞAMANDIRALI HAVALANDIRMA

SUITABLE 800 LT - 1000 LT - 1200 LT - 1500 LT - 1600 LT - 2000 LT TANKS RING FOR FLAT SURFACES / FLOATING VENT VALVE

01110K



01102



01112

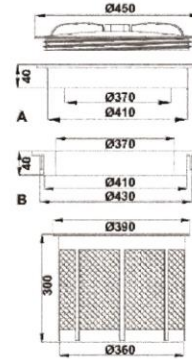

YEDEK PARÇA / SPARE PARTS



Üstten Perçinli  
Flat Surfaces



01102

ÇEMBER  
RING



01112

ELEK  
BASKET FILTER



01013K

HAVALANDIRMA VALFİ  
FLOATING VENT VALVE

01300

TEMİZ SU KAPAĞI / BAYONET LID

درب مخزن آب تمیز

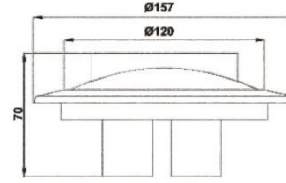

01320

TEMİZ SU KAPAĞI PASOLU Ø 14.5 cm / CLOSED LID

درب مخزن آب تمیز

KAPAK

LID

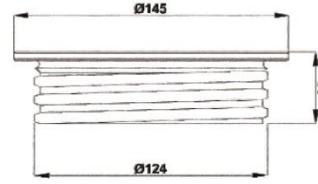

01161

100 - 200 LT PASOLU KAPAK / THREADED TANK LID

200 LT KAPAK

200 LT LID

**01200****400 LT DOLDURUCU / ENJECTOR (WITH SUCTION FITTING)**

50-60-68-72-80-90 CM BORU SEÇENEKLERİ MEME DELİK ÇAPI Ø 3 MM

50-60-68-72-80-90 CM PIPES ON REGUEST NOZZLE SIZE Ø 3 MM

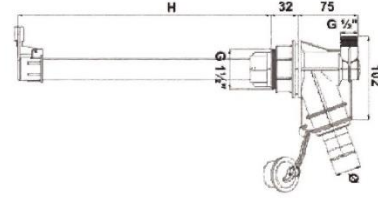
**ست پرکن****H**

50 cm
60 cm
68 cm
72 cm
80 cm
90 cm

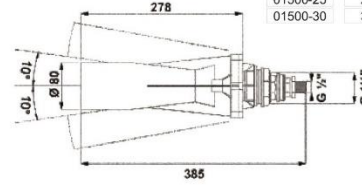
**01500****MAXI MIX KARIŞTIRICI / MAXI MIX AGITATOR****همزن ۳۸۵ میلیمتر ماکسی**

KOD CODE	Ø	UÇ NOZZLE
01500-15	1.5 mm	SERAMİK CERAMIC
01500-20	2.0 mm	
01500-25	2.5 mm	
01500-30	3.0 mm	

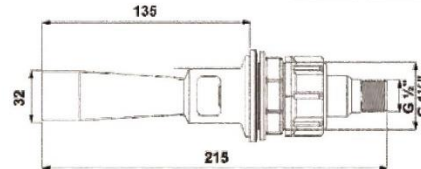
**01400****HIDRO MIX KARIŞTIRICI / HIDRO MIX AGITATOR****همزن ۲۰۵ میلیمتر هیدرو**

KOD CODE	Ø	UÇ NOZZLE
01400-12	1.2 mm	SERAMİK CERAMIC
01400-15	1.5 mm	
01400-30	3.0 mm	

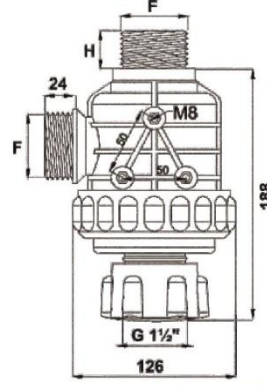
**02040****150 LT ÇEK VALFLİ FİLTRE / SUCTION FILTER WITH VALVE**1 ½" GAS PASO / M8 PİRİNÇ BAĞLATI SOMUNLARI KOLAY FİLTRE TEMİZLİĞİ İÇİN ÇEK VALF KİTİ  
ÇEK VALF GİRİŞİNDEN DEPO DOLDURMA İMKANI**فیلتر سوپاپ دار ۱۵۰ لیتری**1 ½" BSP THREADS / M8 BRASS INSERTS SHUT-OFF VALVE FOR EASY FILTER CLEANING  
ADDITIONAL SUCTION INLET TO FILL THE TANK (FROM THE SHUT OFF VALVE)

F	H	MESH	SÜZGEÇ CARTRIDGE
G 1 ½"	40	30 MESH 50 MESH 80 MESH	INOX

**YEDEK PARÇA / SPARE PARTS****02010**FİLTRE ANAHTARI  
FILTER LOCK TOOL**02045**ÇEK VALF KİTİ  
SHUT-OFF VALVE**02046**SÜZGEÇ  
CARTRIDGE**02000****150 LT DÜZ FİLTRE / SUCTION FILTER**

1 ½" GAS PASO / M8 PİRİNÇ BAĞLATI SOMUNLARI

**فیلتر ۱۵۰ لیتری**

1 ½" BSP THREADS / M8 BRASS INSERTS

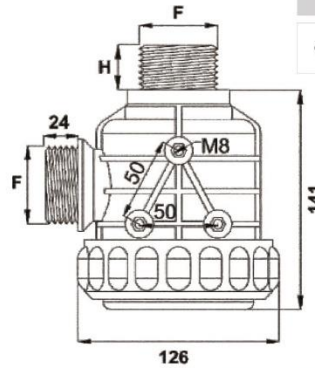

F	H	MESH	SÜZGEÇ CARTRIDGE
G 1 ½"	40	30 MESH 50 MESH 80 MESH	INOX

**YEDEK PARÇA / SPARE PARTS****02010**FİLTRE ANAHTARI  
FILTER LOCK TOOL**02046**SÜZGEÇ  
CARTRIDGE

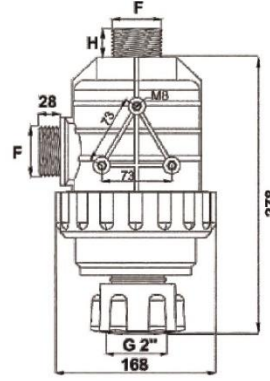
**02200****180 LT ÇEK VALFLİ FİLTRE / SUCTION FILTER WITH VALVE**1 ½" GAS PASO / M8 PİRİNÇ BAĞLARI SOMUNLARI KOLAY FİLTRE TEMİZLİĞİ İÇİN ÇEK VALF KİTİ  
ÇEK VALF GİRİŞİNDEN DEPO DOLDURMA İMKANI**فیلتر سوپاپ دار ۱۸۰ لیتری**1 ½" BSP THREADS / M8 BRASS INSERTS SHUT-OFF VALVE FOR EASY FILTER CLEANING  
ADDITIONAL SUCTION INLET TO FILL THE TANK (FROM THE SHUT OFF VALVE)

F	H	MESH	SÜZGEÇ CARTRIDGE
G 1½"	44	30 MESH 50 MESH 80 MESH	INOX

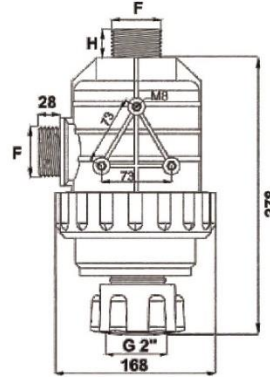
**YEDEK PARÇA / SPARE PARTS****02010**FİLTRE ANAHTARI  
FILTER LOCK TOOL**02045**ÇEK VALF KİTİ  
SHUT-OFF VALVE**02046**SÜZGEÇ  
CARTRIDGE**02280****220 LT ÇEK VALFLİ FİLTRE / SUCTION FILTER WITH VALVE**2" GAS PASO / M8 PİRİNÇ BAĞLARI SOMUNLARI KOLAY FİLTRE TEMİZLİĞİ İÇİN ÇEK VALF KİTİ  
ÇEK VALF GİRİŞİNDEN DEPO DOLDURMA İMKANI**فیلتر سوپاپ دار ۲۲۰ لیتری**2" BSP THREADS / M8 BRASS INSERTS SHUT-OFF VALVE FOR EASY FILTER CLEANING  
ADDITIONAL SUCTION INLET TO FILL THE TANK (FROM THE SHUT OFF VALVE)

F	H	MESH	SÜZGEÇ CARTRIDGE
G 2"	44	30 MESH 50 MESH 80 MESH	INOX

**YEDEK PARÇA / SPARE PARTS****02010**FİLTRE ANAHTARI  
FILTER LOCK TOOL**02045**ÇEK VALF KİTİ  
SHUT-OFF VALVE**02046**SÜZGEÇ  
CARTRIDGE

**02500****220 LT ÜÇ YOLLU AYIRICI KOLLU FİLTRE / SUCTION FILTER WITH 3 WAY SELECTING VALVE****فیلتر ۲۲۰ لیتری ۳ طرفه شیردار**

2" GAS PASO / M8 PİRİNÇ BAĞLATI SOMUNLARI

2" BSP THREADS / M8 BRASS INSERTS

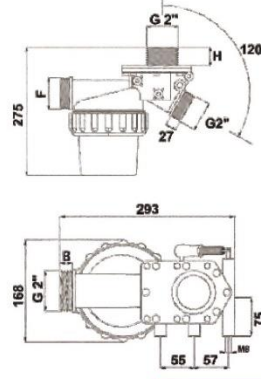

F	H	MESH	SÜZGEÇ CARTRIDGE
G 2"	42	30 MESH 50 MESH 80 MESH	INOX

**YEDEK PARÇA / SPARE PARTS****02010**FİLTRE ANAHTARI  
FILTER LOCK TOOL**02046**SÜZGEÇ  
CARTRIDGE**02550****260 LT ÜÇ YOLLU AYIRICI KOLLU FİLTRE / SUCTION FILTER WITH 3 WAY SELECTING VALVE****فیلتر ۲۶۰ لیتری ۳ طرفه شیردار**

2" GAS PASO / M8 PİRİNÇ BAĞLATI SOMUNLARI

2" BSP THREADS / M8 BRASS INSERTS

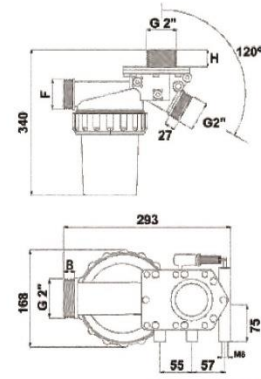

F	H	MESH	SÜZGEÇ CARTRIDGE
G 2"	42	30 MESH 50 MESH 80 MESH	INOX

**YEDEK PARÇA / SPARE PARTS****02010**FİLTRE ANAHTARI  
FILTER LOCK TOOL**02047**SÜZGEÇ  
CARTRIDGE

02720

BÜYÜK PİRİNÇ BASINÇ FİLTRESİ / BRASS HIGH PRESSURE LINE FILTER

TURBO ATOMİZÖRLER İÇİN YÜKSEK BASINÇ FİLTRESİ ½" GAS PASO GİRİŞ ÇIKIŞ MAX BASINÇ 50 BAR

## فیلتر برنجی شیر دار رزوه ۱/۲

HIGH PRESSURE LINE FILTER FOR ATOMIZERS ½" BSP THREADS INLET-OUTLET  
MAX OPERATING PRESSURE 50 BAR

F	H	MESH	SÜZGEÇ CARTRIDGE
G ½"	50	30 MESH 50 MESH 80 MESH	INOX

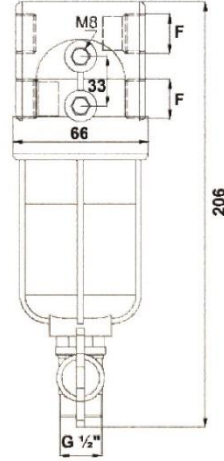

02740

KÜÇÜK PİRİNÇ BASINÇ FİLTRESİ / BRASS HIGH PRESSURE LINE FILTER

TURBO ATOMİZÖRLER İÇİN YÜKSEK BASINÇ FİLTRESİ ½" GAS PASO GİRİŞ ÇIKIŞ MAX BASINÇ 50 BAR

## فیلتر برنجی ۱۱۰ میلی متری

HIGH PRESSURE LINE FILTER FOR ATOMIZERS ½" BSP THREADS INLET-OUTLET  
MAX OPERATING PRESSURE 50 BAR

F	H	MESH	SÜZGEÇ CARTRIDGE
G ½"	50	30 MESH 50 MESH 80 MESH	INOX

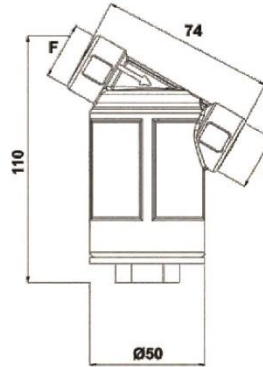



02750

HAT FİLTRESİ 20 BAR / LINE FILTER 20 BAR

MAX BASINÇ 20 BAR ÇİFT TARAFLI BAĞLANTI İMKANI

فیلتر ۲۰ بار خطی

MAX OPERATING PRESSURE 20 BAR CAN BE FIXED IN BOTH SIDES

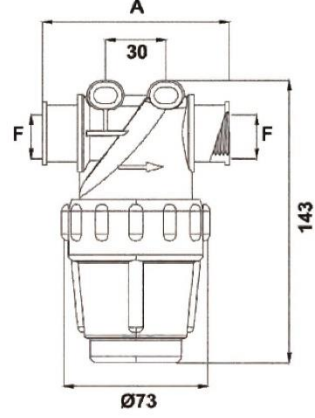

02800

PLASTİK KÜRESEL VANA ÜÇ YOLLU / 3 WAY BALL VALVE

G 1½" ÜÇ YOLLU KÜRESEL VANA M8 PİRİNÇ BAĞLANTI SOMUNLARI

شیر سه راه

3 WAY BALL VALVE G 1½" / M8 BRASS FITTINGS

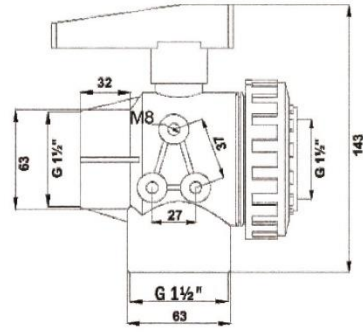

02650

KROM TELLİ DEREDEN ALICI / FOOT STRAINERS

فیلتر پر کن قطر ۳۲ میلی متر

Ø 32

INOX CARTRIDGE

Ø 32

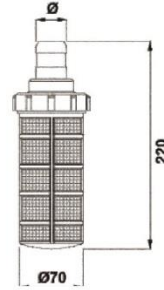

03410

TAHLİYE REKORU / THREADED HOSETAIL KIT

سر شیلنگ برگشت به رگلاتور

G 1/2" - Ø 21

G 1/2" - Ø 21

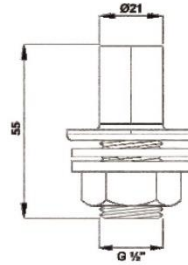

03470

DEPO BOŞALTIMA SİSTEMİ / TANK OUTLET KIT

ست تخلیه مخزن

G 1 1/2"

G 1 1/2"

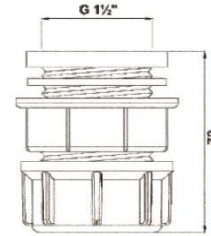



<b>03600</b>	<b>ANAFOR KESİCİ / ANTI VORTEX KIT</b>	<b>ضد گرداب قطر ۱/۲ - ارتفاع ۸۰</b>
G 1 1/2"	KÜÇÜK ŞAPKALI	G 1 1/2"

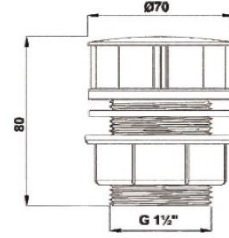

<b>03620</b>	<b>ANAFOR KESİCİ / ANTI VORTEX KIT</b>	<b>ضد گرداب قطر ۱/۲ - ارتفاع ۹۰</b>
G 1 1/2"	UZUN PASOLU	G 1 1/2"

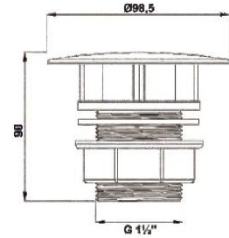

03720

ANAFOR KESİCİ / ANTI VORTEX KIT

ضدگردآب با زانوی ۹۰ درجه قطر ۴۰

G 1 1/2" - Ø 40 DİRSEKLİ

KÜÇÜK ŞAPKALI

G 1 1/2" - Ø 40 WITH 90° HOSETAIL

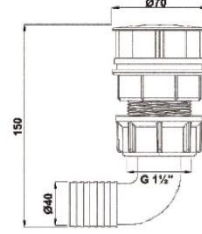

03740

ANAFOR KESİCİ / ANTI VORTEX KIT

ضدگردآب با زانوی ۹۰ درجه قطر ۴۰

G 1 1/2" - Ø 40 DİRSEKLİ

UZUN PASOLU

G 1 1/2" - Ø 40 WITH 90° HOSETAIL

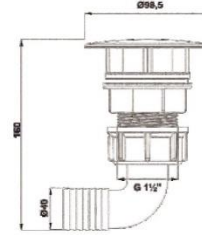

زانوی ۹۰ درجه نشانگر آب قطر ۲۰ میلی

03820

SEVİYE GÖSTERGE DİRSEK TAKIMI / TANK LEVEL INDICATOR KIT

1/2" - Ø 20



## نازل بوم مه پاش

04000

KELEPÇELİ MEME / SPLIT EYELET NOZZLE - HOLLOW CONE



Ø

Ø 1.0

Ø 1.2

Ø 1.5

## نازل بوم تی جت خطی

04010

KELEPÇELİ MEME / SPLIT EYELET NOZZLE - HOLLOW CONE



04220

DAMLA KESİCİLİ PLASTİK TARLA MEMESİ 3'LÜ

3 WAY NOZZLE WITH DIAPHRAGM CHECK VALVE COMPLETE KIT



## نازل سه راه پلاستیکی

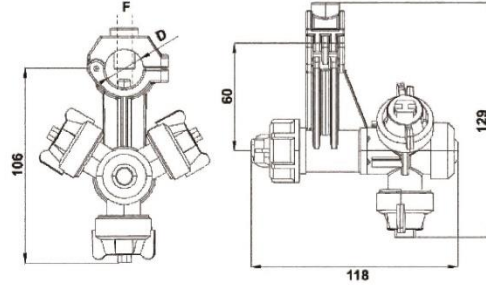

YEDEK PARÇA / SPARE PARTS



04240

DAMLA KESİCİLİ PLASTİK TARLA MEMESİ TEKLİ (EKO)

NOZZLE WITH DIAPHRAGM CHECK VALVE COMPLETE KIT (ECO)



YEDEK PARÇA / SPARE PARTS



## نازل برنزی اتومايزر

04710

TURBO ATOMIZÖR MEME / NOZZLE FOR ATOMIZOR

PIRİNÇ AYARLANABİLİR DAMLA KESİCİLİ MEME

BRASS ADJUSTABLE NOZZLE FOR ATOMIZOR

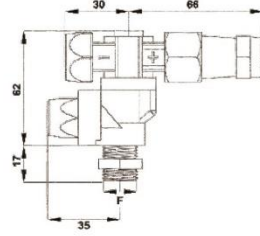

## نازل برنزی اتومايزر روکش دار

04720

TURBO ATOMIZÖR MEME / NOZZLE FOR ATOMIZOR

PIRİNÇ AYARLANABİLİR DAMLA KESİCİLİ MEME (ŞAPKALI)

BRASS ADJUSTABLE NOZZLE FOR ATOMIZOR

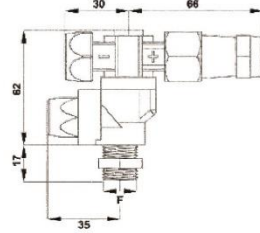

## لانس دسته بلند

04500

UZUN İLAÇLAMA TABANCASI / HANDLE SPRAY GUN

04510

KISA İLAÇLAMA TABANCASI / HANDLE SPRAY GUN



شیر دسته بلند ۱/۲ به ۱/۲ ماده

05000	KOLLU VANA / BALL VALVE
G 1/2" D 1/2" D G 1/2" F 1/2" F	



شیر دسته بلند ۱/۲ به ۳/۸ نر

05004	KOLLU VANA / BALL VALVE
G 1/2" E 3/8" E G 1/2" M 3/8" M	



شیر دسته پروانه ای ۱/۲ ماده به ۱/۲ نر

05050	KELEBEK VANA / BALL VALVE
G 1/2" E 1/2" D G 1/2" M 1/2" F	



شیر دسته پروانه ای ۱/۲ به ۱/۲ نر

05054	KELEBEK VANA / BALL VALVE
G 1/2" E 1/2" E G 1/2" M 1/2" M	



شیر دسته بلند ۱/۲ به ۱/۲ نر

05002	KOLLU VANA / BALL VALVE
G 1/2" E 1/2" E G 1/2" M 1/2" M	



شیر دسته بلند ۱/۲ ماده به ۱/۲ نر

05006	KOLLU VANA / BALL VALVE
G 1/2" E 1/2" D G 1/2" M 1/2" F	



شیر ۳/۸ ماده به ۳/۸ نر

05052	KELEBEK VANA / BALL VALVE
G 3/8" E 3/8" D G 3/8" M 3/8" F	



هرزگرد برنجی ۱/۲

05102	L - DÖNER NİPEL / L - SWİEL FITTING
G 1/2" D G 1/2" F	



### بست بوم ۲۵ \* ۲۵

05400

METAL KOL KELEPÇESİ / SPRAY BOOM SUPPORT CLAMP



Ø ½"



25x25mm



### بست بوم ۳۰ \* ۳۰

05402

METAL KOL KELEPÇESİ / SPRAY BOOM SUPPORT CLAMP



Ø ½"



30x30mm



### بست بوم ۴۰ \* ۴۰

05404

METAL KOL KELEPÇESİ / SPRAY BOOM SUPPORT CLAMP



Ø ½"



40x40mm



### بست بوم ۵۰ \* ۵۰

05406

METAL KOL KELEPÇESİ / SPRAY BOOM SUPPORT CLAMP



Ø ½"



50x50mm





## شىلنگ ۱۰ مىلى ۹۰ بار



İÇ ÇAP INNER DIAMETER	DIŞ ÇAP OUTER DIAMETER	ÇALIŞMA BASINCI WORKING PRESS	PATLAMA BASINCI BURSTING PRESS
8 mm	15 mm	40 BAR	120 BAR
10 mm	17 mm	40 BAR	120 BAR
10 mm	19 mm	90 BAR	240 BAR

TUBE : SPECIAL PVC COMPOUND RESISTANT TO PESTICIDES AND FERTILIZERS  
COVER : ABRASION OZONE AND WEATHER RESISTANT SPECIAL PVC COMPOUND  
REINFORCEMENT : HIGH TENSILE SYNTHETIC TEXTILE  
APPLICATION : FOR SPRAYING OF PESTICIDES AND FERTILIZERS IN AGRICULTURE

## توپى نشانگر آب

05520

GÖSTERGE BONCUĞU / LEVEL INDICATOR BALL



KOD CODE	DIŞ ÇAP OUTER DIAMETER
05520-11	11 mm
05520-14	14 mm
05520-17	17 mm

## كاور محافظ شفت گاردان

06002

APS 121-145 / IDS ŞAFT MUHAFAZASI / CARDAN PROTECTION

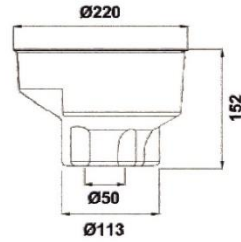



06102

BASINÇ EMNİYET SİBOBU / SAFETY VALVE

### فشار شکن رزوه ۱/۲

G ۱/۲"



P (BAR)

40

50

06120

BASINÇ EMNİYET SİBOBU / SAFETY VALVE

### فشار شکن رزوه ۳/۸

G ۳/۸"



P (BAR)

40

50

### استکان روغن پلاستیکی C71

06200 503 YAĞDANLIK - PLASTİK / OIL CAN



### استکان روغن پمپ درب پیچی

06210 904-1064-1516 YAĞDANLIK - PLASTİK / OIL CAN



### استکان روغن پمپ درب پیچی C96 و C145

06230 APS 96-145 YAĞDANLIK - PLASTİK / OIL CAN



### استکان روغن پمپ C71

06220 APS 31-41-51-61-71 YAĞDANLIK - PLASTİK / OIL CAN



### استکان روغن پمپ C145 و C96

06242 APS 96-145 YAĞDANLIK - ŞEFFAF / OIL CAN TRANSPARENT

KİLİTLİ KAPAK / LID LOCK



### سوپاپ پمپ C145

06504 APS 101-121-141-145-166 SİBOP / SUCTION DELIVERY VALVE



### سوپاپ پمپ C96 و C71

06502 APS 51-61-71-96 SİBOP / SUCTION DELIVERY VALVE



شیر دسته پروانه ای شستشوی دست

07402

PLASTİK MUSLUK / HAND WASHING TAP



شیر دسته پروانه ای شستشوی دست

07400

PLASTİK MUSLUK / HAND WASHING TAP



سرسره پلاستیکی تیپ V

07360

PLASTİK KIZAK V TAKOZU / PLASTIC WEDGE (V)



## رگلاتور گلنگدنی سه راه ۴۰ بار

06700

REGÜLATÖR 3 ÇIKIŞLI / 3 WAY PRESSURE CONTROL UNIT

MAX. 40 BAR ÇALIŞMA BASINCI 100 lt / dk. MAX. DEBİ

40 BAR MAX. OPERATING PRESSURE 100 lt / MIN. MAXIMUM FLOW RATE

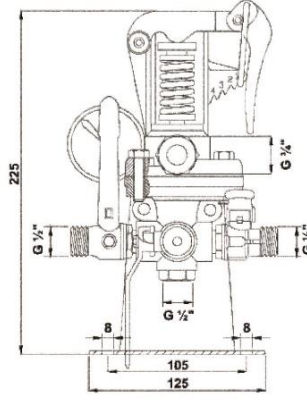

### YEDEK PARÇA / SPARE PARTS



05140

AYAR SOMUNU  
ADJUSTING NUT



03254

BAĞLANTI SOMUNU  
FLY NUT



03000

GERİ DÖNÜŞ DIRSEĞİ  
HOSE TAILS FOR FLY NUT

## رگلاتور ۳ راه اهرمی ۵۰ بار

06702

VDR 50 REGÜLATÖR 3 ÇIKIŞLI / VDR 50 - 3 WAY PRESSURE CONTROL UNIT

## رگلاتور ۵ راه اهرمی ۵۰ بار

06704

VDR 50 REGÜLATÖR 5 ÇIKIŞLI / VDR 50 - 5 WAY PRESSURE CONTROL UNIT



## گیج فشار ۱۰۰ بار

06750

BASINÇ SAATİ (GLİSERİN DOLGULU) / PRESSURE GAUGE (GLYCERINE)



06905

C71 POMPA / C 71 PUMP

پمپ C71



Açıklama:

- 3 Membranlı Yüksek Basıncı Pompa
- İçten manifoldlu
- Sıboop pulu ve kapakları paslanmaz çeliktir
- Pompa üzerinde basınç emniyet sibobu ve harici vana mevcuttur.

Description:

- High pressure diaphragm pump 3 diaphragm type
- Internal manifolds
- Valves with plate and seat in stainless steel
- Safety valve and discharge tap

06910

C96 POMPA / C 96 PUMP

پمپ C96 ساده و پمپ C96 دو سر شفت



Açıklama:

- 4 Membranlı Yüksek Basıncı Pompa
- İçten manifoldlu
- Sıboop pulu ve kapakları paslanmaz çeliktir
- Pompa üzerinde basınç emniyet sibobu ve harici vana mevcuttur.

Description:

- High pressure diaphragm pump 4 diaphragm type
- Internal manifolds
- Valves with plate and seat in stainless steel
- Safety valve and discharge tap

06930

C 145 POMPA / C 145 PUMP

پمپ C145



Açıklama:

- 4 Membranlı Yüksek Basıncı Pompa
- İçten manifoldlu
- Sıboop pulu ve kapakları paslanmaz çeliktir
- Kayış ve kasnak ile kullanıma uygundur
- Hava kabı mevcuttur

Description:

- High pressure diaphragm pump 4 diaphragm type
- Internal manifolds
- Valves with plate and seat in stainless steel
- With pressure accumulator
- Suitable for pulley use

133050001

ŞANZİMAN / GEARBOXES

گیربکس فن سیمپاش دو سرعته کوچک

